

Dual Common-Cathode Schottky Rectifier

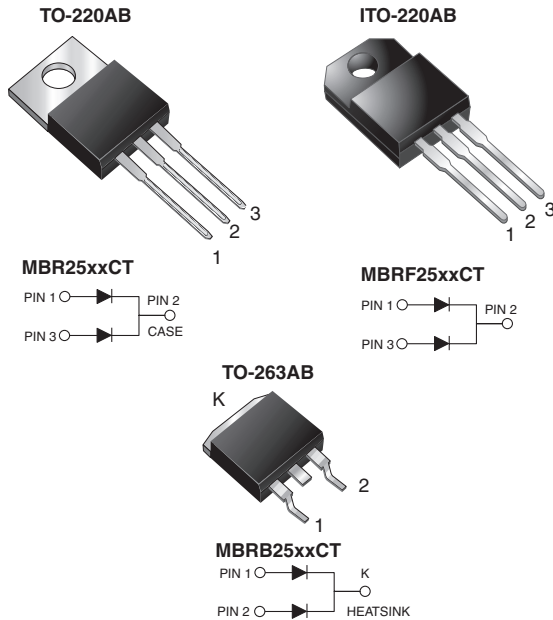

FEATURES

- Guardring for overvoltage protection
- Lower power losses, high efficiency
- Low forward voltage drop
- High forward surge capability
- High frequency operation
- Meets MSL level 1, per J-STD-020C, LF maximum peak of 245 °C (for TO-263AB package)
- Solder dip 260 °C, 40 s (for TO-220AB and ITO-220AB package)
- Component in accordance to RoHS 2002/95/EC and WEEE 2002/96/EC



RoHS
COMPLIANT

TYPICAL APPLICATIONS

For use in low voltage, high frequency rectifier of switching mode power supplies, freewheeling diodes, dc-to-dc converters or polarity protection application.

MECHANICAL DATA

Case: TO-220AB, ITO-220AB, TO-263AB

Epoxy meets UL 94V-0 flammability rating

Terminals: Matte tin plated leads, solderable per J-STD-002B and JESD22-B102D

E3 suffix for consumer grade, meets JESD 201 class 1A whisker test, HE3 suffix for high reliability grade (AEC Q101 qualified), meets JESD 201 class 2 whisker test

Polarity: As marked

Mounting Torque: 10 in-lbs maximum

PRIMARY CHARACTERISTICS

| | |
|--------------------|--------------------------------|
| $I_{F(AV)}$ | 15 A x 2 |
| V_{RRM} | 35 V to 60 V |
| I_{FSM} | 150 A |
| V_F | 0.73 V at 30 A, 0.65 V at 15 A |
| $T_J \text{ max.}$ | 150 °C |

MAXIMUM RATINGS ($T_C = 25\text{ °C}$ unless otherwise noted)

| PARAMETER | SYMBOL | MBR2535CT | MBR2545CT | MBR2550CT | MBR2560CT | UNIT |
|--|-------------|-----------|-----------|-----------|-----------|------|
| Maximum repetitive peak reverse voltage | V_{RRM} | 35 | 45 | 50 | 60 | V |
| Working peak reverse voltage | V_{RWM} | 35 | 45 | 50 | 60 | |
| Maximum DC blocking voltage | V_{DC} | 35 | 45 | 50 | 60 | |
| Maximum average forward rectified current total device at $T_C = 130\text{ °C}$ per diode | $I_{F(AV)}$ | 30 15 | | | | A |
| Peak forward surge current 8.3 ms single half sine-wave superimposed on rated load per diode | I_{FSM} | 150 | | | | A |
| Peak repetitive reverse surge current per diode at $t_p = 2\ \mu\text{s}$, 1 kHz | I_{RRM} | 1.0 | | 0.5 | | |
| Peak non-repetitive reverse energy (8/20 μs waveform) per diode | E_{RSM} | 25 | | | | mJ |
| Electrostatic discharge capacitor voltage human body model: $C = 100\ \text{pF}$, $R = 1.5\ \text{k}\Omega$ | V_C | 25 | | | | kV |

MBR(F,B)2535CT thru MBR(F,B)2560CT

Vishay General Semiconductor



| MAXIMUM RATINGS (T _C = 25 °C unless otherwise noted) | | | | | | |
|---|------------------|---------------|-----------|-----------|-----------|------|
| PARAMETER | SYMBOL | MBR2535CT | MBR2545CT | MBR2550CT | MBR2560CT | UNIT |
| Voltage rate of change (rated V _R) | dV/dt | 10 000 | | | | V/μs |
| Operating junction temperature range | T _J | - 65 to + 150 | | | | °C |
| Storage temperature range | T _{STG} | - 65 to + 175 | | | | |
| Isolation voltage (ITO-220AB only) from terminal to heatsink t = 1 min | V _{AC} | 1500 | | | | V |

| ELECTRICAL CHARACTERISTICS (T _C = 25 °C unless otherwise noted) | | | | | | | |
|--|-----------------------|---|----------------|-----------|-----------|-----------|------|
| PARAMETER | TEST CONDITIONS | SYMBOL | MBR2535CT | MBR2545CT | MBR2550CT | MBR2560CT | UNIT |
| Maximum instantaneous forward voltage per diode ⁽¹⁾ | I _F = 15 A | T _C = 25 °C | - | - | 0.75 | - | V |
| | I _F = 15 A | T _C = 125 °C | - | - | 0.65 | - | |
| | I _F = 30 A | T _C = 25 °C | 0.82 | - | - | - | |
| | I _F = 30 A | T _C = 125 °C | 0.73 | - | - | - | |
| Maximum instantaneous reverse current at blocking voltage per diode ⁽¹⁾ | | T _C = 25 °C T _C = 125 °C | I _R | 0.2 40 | 1.0 50 | | mA |

Note:

(1) Pulse test: 300 μs pulse width, 1 % duty cycle

| THERMAL CHARACTERISTICS (T _C = 25 °C unless otherwise noted) | | | | | |
|---|------------------|-----|------|------|------|
| PARAMETER | SYMBOL | MBR | MBRF | MBRB | UNIT |
| Typical thermal resistance from junction to case per diode | R _{θJC} | 1.5 | 4.5 | 1.5 | °C/W |

| ORDERING INFORMATION (Example) | | | | | |
|--------------------------------|---------------------------------|-----------------|--------------|---------------|---------------|
| PACKAGE | PREFERRED P/N | UNIT WEIGHT (g) | PACKAGE CODE | BASE QUANTITY | DELIVERY MODE |
| TO-220AB | MBR2545CT-E3/45 | 1.85 | 45 | 50/tube | Tube |
| ITO-220AB | MBRF2545CT-E3/45 | 1.99 | 45 | 50/tube | Tube |
| TO-263AB | MBRB2545CT-E3/45 | 1.35 | 45 | 50/tube | Tube |
| TO-263AB | MBRB2545CT-E3/81 | 1.35 | 81 | 800/reel | Tape reel |
| TO-220AB | MBR2545CTHE3/45 ⁽¹⁾ | 1.85 | 45 | 50/tube | Tube |
| ITO-220AB | MBRF2545CTHE3/45 ⁽¹⁾ | 1.99 | 45 | 50/tube | Tube |
| TO-263AB | MBRB2545CTHE3/45 ⁽¹⁾ | 1.35 | 45 | 50/tube | Tube |
| TO-263AB | MBRB2545CTHE3/81 ⁽¹⁾ | 1.35 | 81 | 800/reel | Tape reel |

Note:

(1) Automotive grade AEC Q101 qualified



RATINGS AND CHARACTERISTICS CURVES

($T_A = 25\text{ }^\circ\text{C}$ unless otherwise noted)

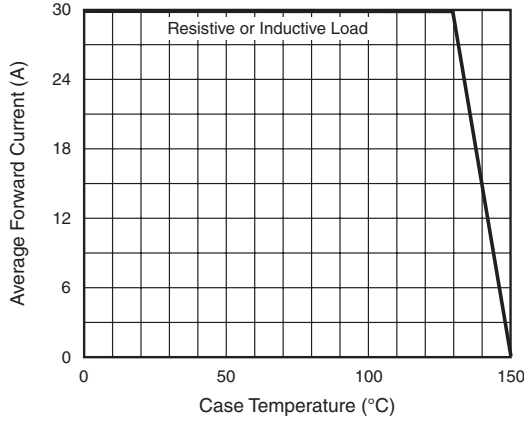

Figure 1. Forward Current Derating Curve

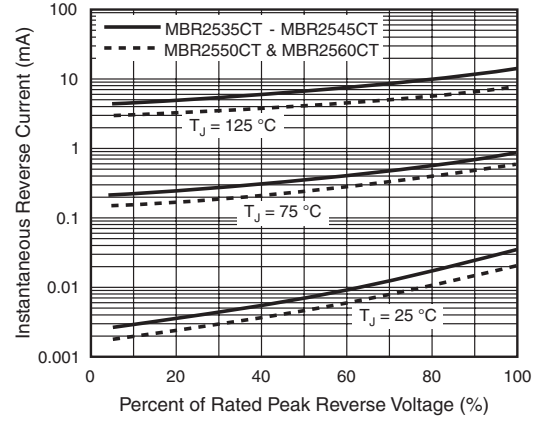

Figure 4. Typical Reverse Characteristics Per Diode

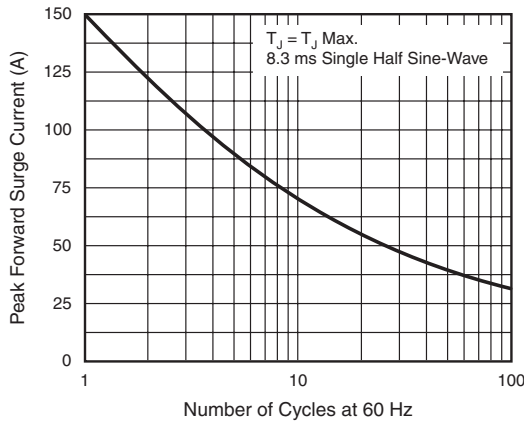

Figure 2. Maximum Non-Repetitive Peak Forward Surge Current Per Diode

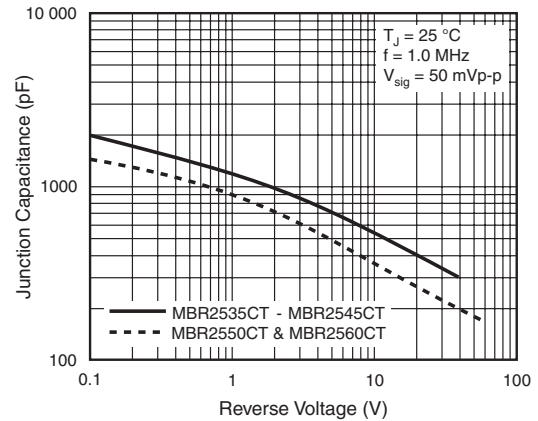

Figure 5. Typical Junction Capacitance Per Diode

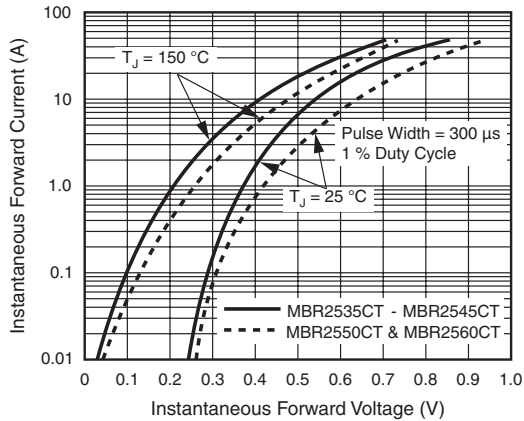

Figure 3. Typical Instantaneous Forward Characteristics Per Diode

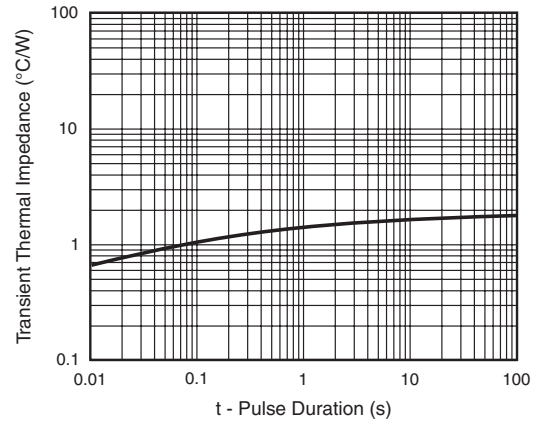

Figure 6. Typical Transient Thermal Impedance Per Diode

MBR(F,B)2535CT thru MBR(F,B)2560CT

Vishay General Semiconductor



PACKAGE OUTLINE DIMENSIONS in inches (millimeters)

TO-220AB

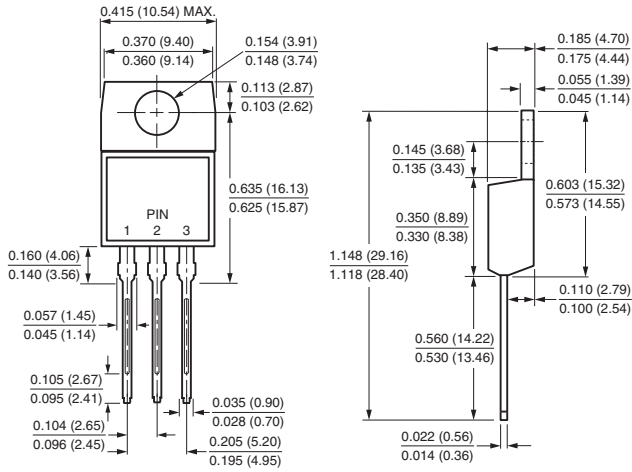

ITO-220AB

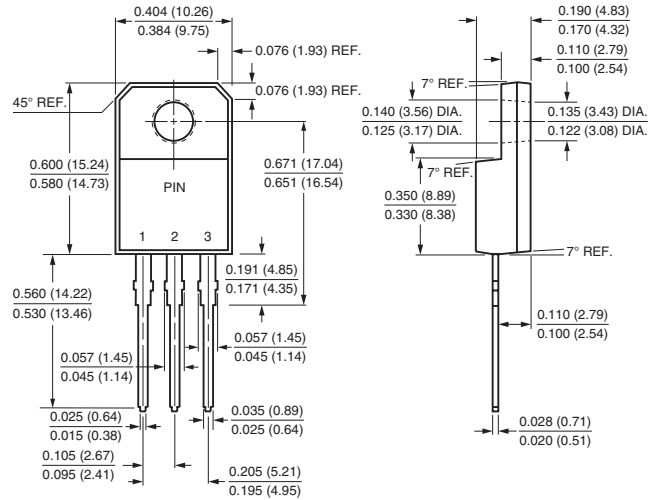

TO-263AB

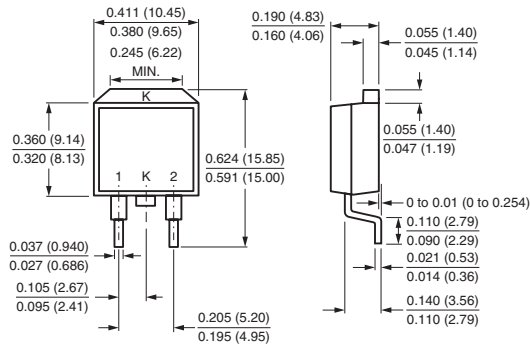

Mounting Pad Layout

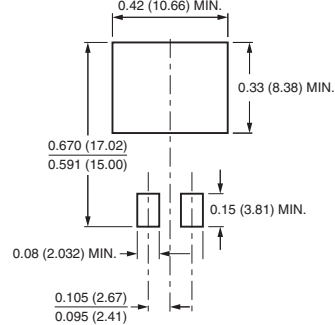



Disclaimer

All product specifications and data are subject to change without notice.

Vishay Intertechnology, Inc., its affiliates, agents, and employees, and all persons acting on its or their behalf (collectively, "Vishay"), disclaim any and all liability for any errors, inaccuracies or incompleteness contained herein or in any other disclosure relating to any product.

Vishay disclaims any and all liability arising out of the use or application of any product described herein or of any information provided herein to the maximum extent permitted by law. The product specifications do not expand or otherwise modify Vishay's terms and conditions of purchase, including but not limited to the warranty expressed therein, which apply to these products.

No license, express or implied, by estoppel or otherwise, to any intellectual property rights is granted by this document or by any conduct of Vishay.

The products shown herein are not designed for use in medical, life-saving, or life-sustaining applications unless otherwise expressly indicated. Customers using or selling Vishay products not expressly indicated for use in such applications do so entirely at their own risk and agree to fully indemnify Vishay for any damages arising or resulting from such use or sale. Please contact authorized Vishay personnel to obtain written terms and conditions regarding products designed for such applications.

Product names and markings noted herein may be trademarks of their respective owners.